

## Three Phase Bridge Rectifiers

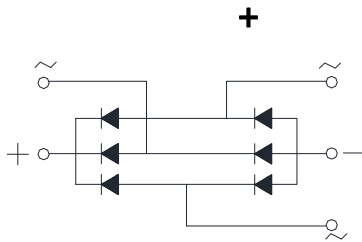
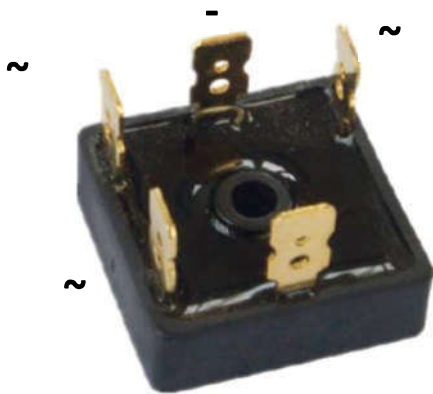

### Features

- Glass passivated chip
- High surge current capability
- Low thermal resistance
- Solder dip 275 °C max. 7 s, per JESD 22-B106

### Typical Applications

General purpose use in AC/DC bridge full wave rectification for power supply, home appliances, office equipment, industrial automation applications.

### Mechanical Data

- **Package:** SKBPC  
Molding compound meets UL 94 V-0 flammability rating, RoHS-compliant
- **Terminals:** Tin plated leads, solderable per J-STD-002 and JESD22-B102

### ■ Maximum Ratings ( $T_a=25^\circ\text{C}$ Unless otherwise specified)

PARAMETER	SYMBOL	UNIT	SKBPC3504	SKBPC3506	SKBPC3508	SKBPC3510	SKBPC3512	SKBPC3514	SKBPC3516
Device marking code			SKBPC3504	SKBPC3506	SKBPC3508	SKBPC3510	SKBPC3512	SKBPC3514	SKBPC3516
Repetitive Peak Reverse Voltage	VRRM	V	400	600	800	1000	1200	1400	1600
Average Rectified Output Current @60Hz sine wave, R-load, With heatsink, $T_c=55^\circ\text{C}$	$I_O$	A	35						
Surge(Non-repetitive)Forward Current @60Hz Half- sine Wave, 1 cycle, $T_a=25^\circ\text{C}$	IFSM	A	400						
Current Squared Time @1ms $\leq$ t $\leq$ 8.3ms $T_j=25^\circ\text{C}$ , Rating of per diode	$I^2t$	A <sup>2</sup> S	660						
Storage Temperature	$T_{stg}$	$^\circ\text{C}$	-55~+150						
Junction Temperature	$T_j$	$^\circ\text{C}$	-55 ~+150						
Dielectric Strength, Terminals to case, AC 1 minute	Vdis	KV	2.5						
Mounting Torque	TOR	kg·cm	10						

### ■ Electrical Characteristics ( $T_a=25^\circ\text{C}$ Unless otherwise specified)

PARAMETER	SYMBOL	UNIT	SKBPC3504	SKBPC3506	SKBPC3508	SKBPC3510	SKBPC3512	SKBPC3514	SKBPC3516
Maximum instantaneous forward voltage drop per diode	VFM	V	IFM=17.5A	1.2					
Maximum DC reverse current at rated DC blocking voltage per diode	I <sub>RRM</sub>	$\mu\text{A}$	VRM=VRRM	10					

### ■ Thermal Characteristics ( $T_a=25^\circ\text{C}$ Unless otherwise specified)

PARAMETER	SYMBOL	UNIT	SKBPC3504	SKBPC3506	SKBPC3508	SKBPC3510	SKBPC3512	SKBPC3514	SKBPC3516
Thermal Resistance Between junction and case, With heatsink	$R_{\theta J-C}$	$^\circ\text{C/W}$	1.3						



# SKBPC3504 THRU SKBPC3516

## Ordering Information (Example)

PREFERRED P/N	PACKAGE CODE	UNIT WEIGHT(g)	MINIMUM PACKAGE(pcs)	INNER BOX QUANTITY(pcs)	OUTER CARTON QUANTITY(pcs)	DELIVERY MODE
SKBPC3504~SKBPC3516	A1	Approximate 17.5	50	50	500	Paper Box

## Characteristics (Typical)

FIG1:Io-Tc Curve

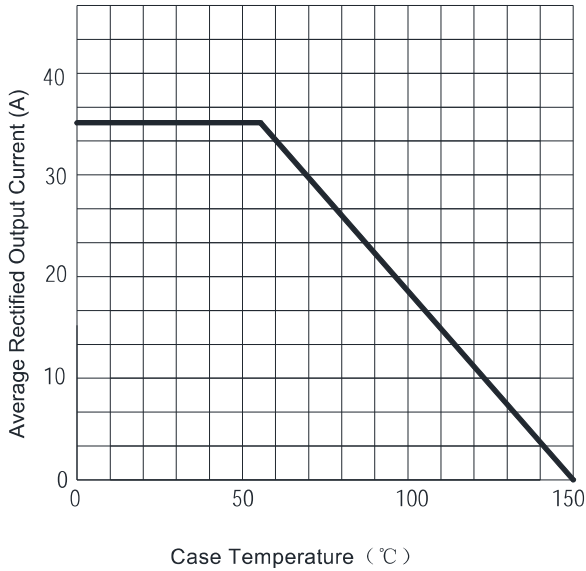

FIG2:Surge Forward Current Capability

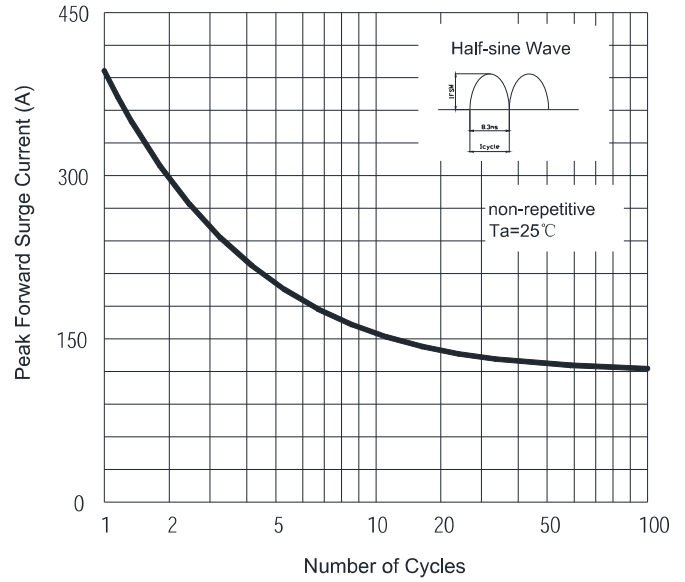

FIG3:Instantaneous Forward Voltage

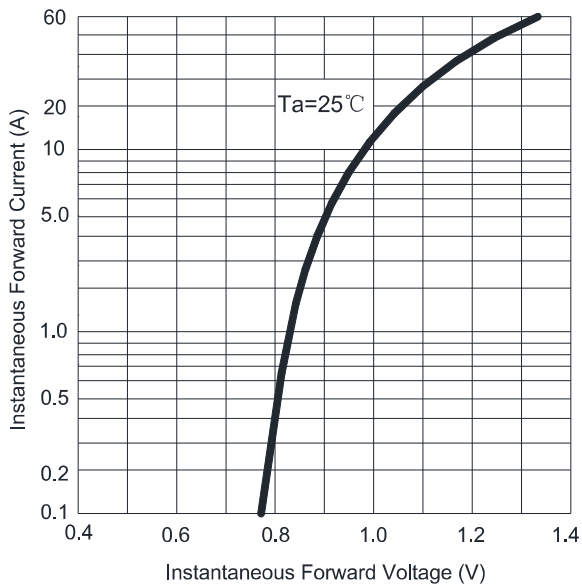
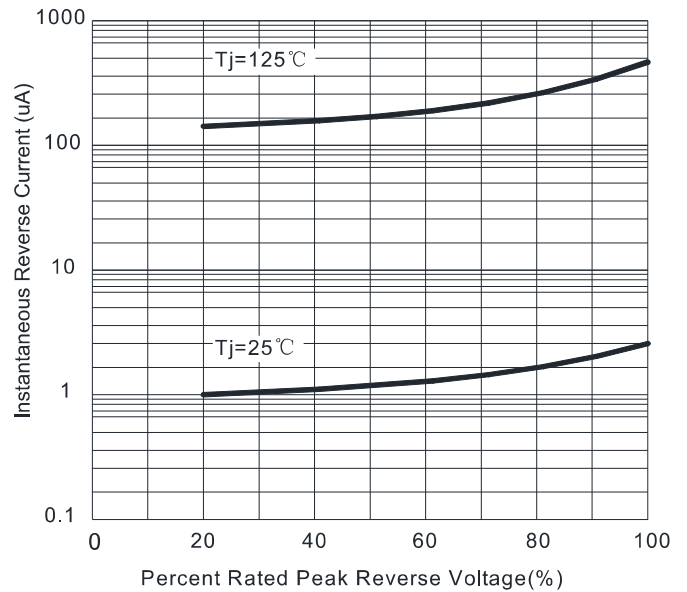
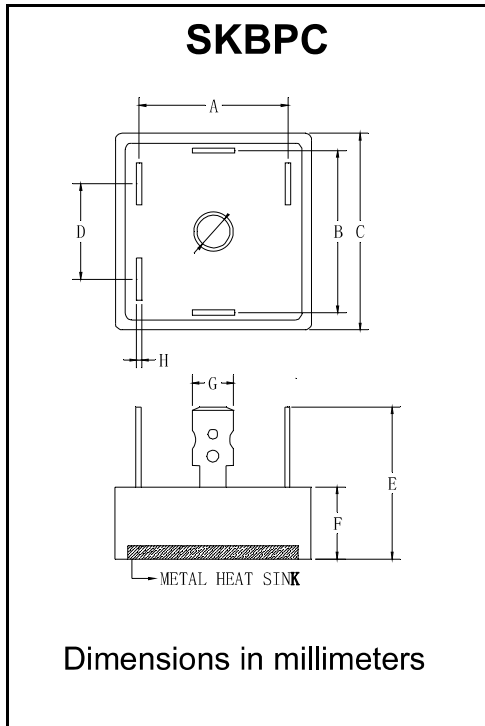

FIG4:Typical Reverse Characteristics



## ■ Outline Dimensions



SKBPC		
Dim	Min	Max
A	23.3	24.3
B	23.3	24.3
C	28.2	28.8
D	15.5	16.5
E	/	25
F	9	10
G	6.2	6.4
H	0.75	0.85



## SKBPC3504 THRU SKBPC3516

---

### Disclaimer

The information presented in this document is for reference only. shenzhen zenivo Electronic Technology Co., Ltd. reserves the right to make changes without notice for the specification of the products displayed herein to improve reliability, function or design or otherwise.

The product listed herein is designed to be used with ordinary electronic equipment or devices, and not designed to be used with equipment or devices which require high level of reliability and the malfunction of which would directly endanger human life (such as medical instruments, transportation equipment, aerospace machinery, nuclear-reactor controllers, fuel controllers and other safety devices), zenivo or anyone on its behalf, assumes no responsibility or liability for any damages resulting from such improper use of sale.

This publication supersedes & replaces all information previously supplied. For additional information, please visit our website [http:// www.zvelec.com](http://www.zvelec.com) , or consult your nearest zenivo's sales office for further assistance.